



panoramic[®] h-line

- Modular exhibits, from 10'x10'
- Packaged in a wheeled crate with frames and graphics preassembled
- May be set up with or without professional assistance

modular exhibits

The reference of modular exhibits

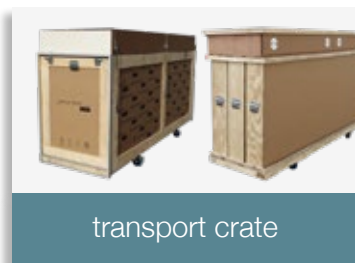
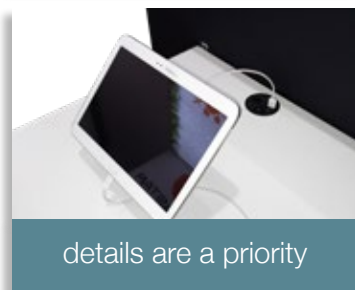
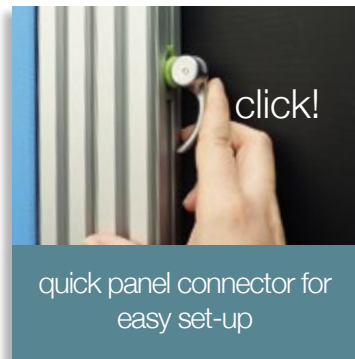

- Create a customized exhibit using pre-assembled modules that offer a wide range of functionalities
- The visual impact of h-line is created through large format, high-definition fabric graphics. The connections between the panels are invisible
- Panoramic h-line is compatible with panoLED: innovate and bring your exhibit to life with panoLED video walls
- Set-up time for an 10'x 20' exhibit is less than an hour

100% modular: 13 modules, 4 shows, 4 configurations, 4 locations

Reconfigure your h-line exhibit to suit your event, using the same pack of modules each time

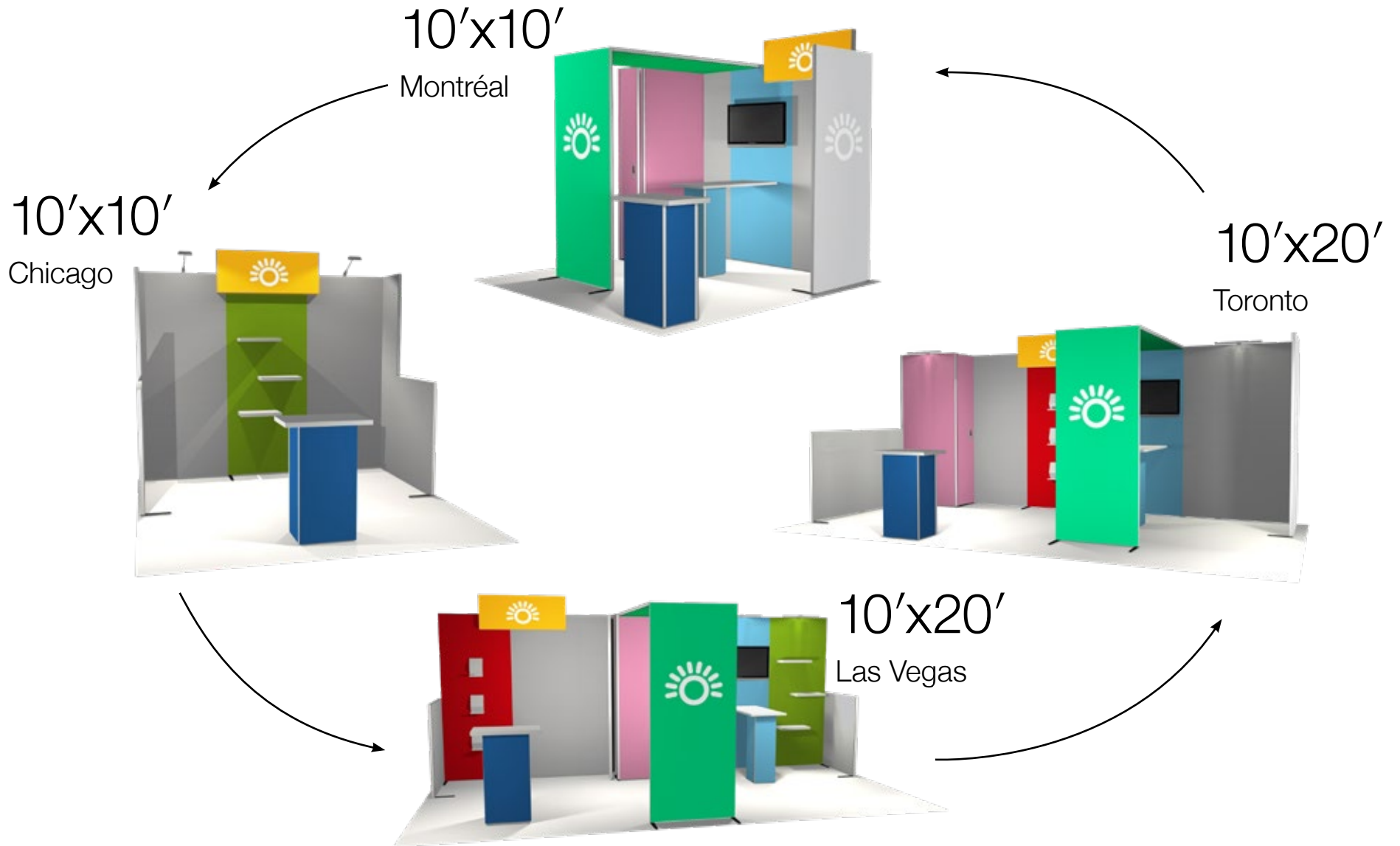

100% modular: 13 modules for an unlimited number of configurations!

13 module pack

- 1 HMS038 standard module
- 1 HMS038-L2 standard lightbox module
- 2 HMS019 standard modules
- 2 HMS138 standard half-height modules
- 1 HMF038-01 brochure-holder module
- 1 HMC338B console module
- 1 HMT012 shelving module
- 1 HMC119 counter module
- 1 HMR119 storage module
- 1 HMH047-L lightbox signage module
- 1 HMV538-L2 lightbox arch module
- 1 SOS kit
- 2 LED lights
- 1 H3 crate

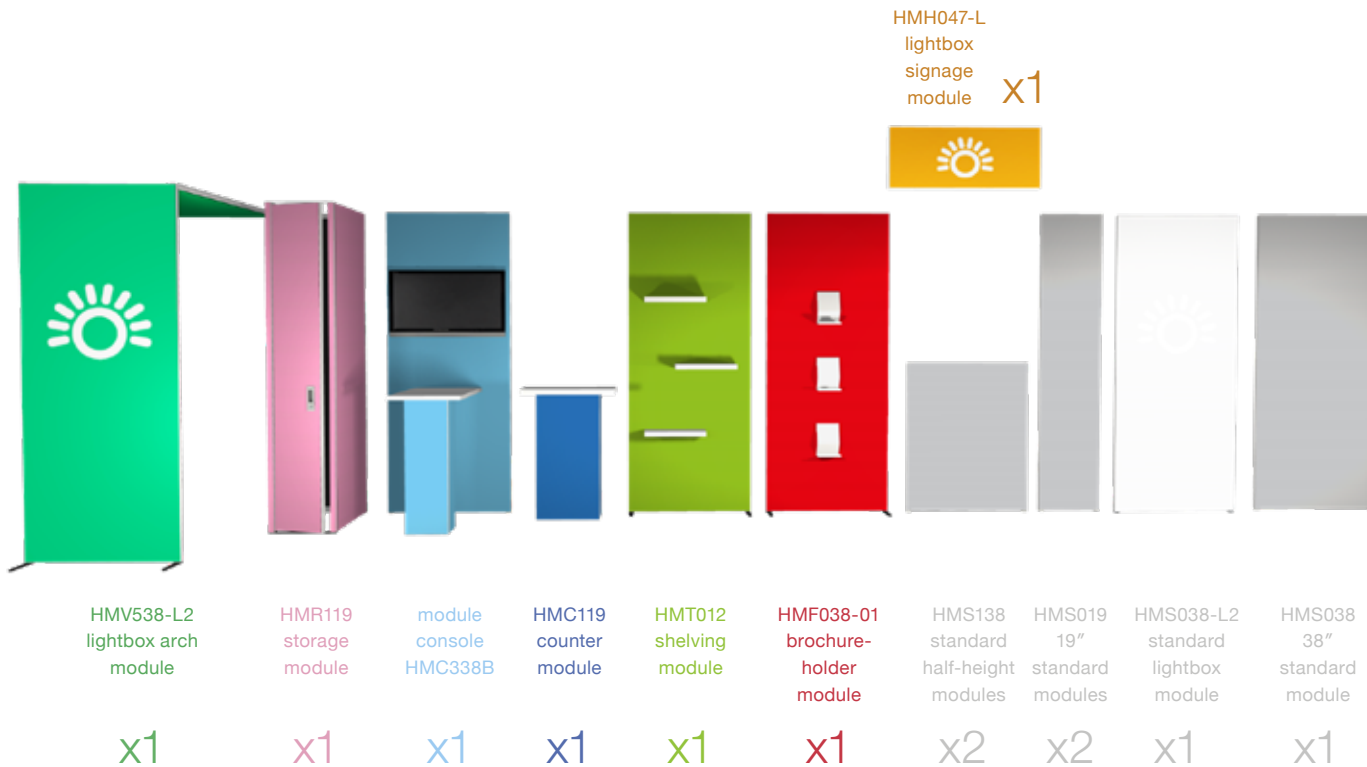

A function for every module

Standard modules



Shelving modules



Standard lightbox modules



Multimedia modules



Accessory modules

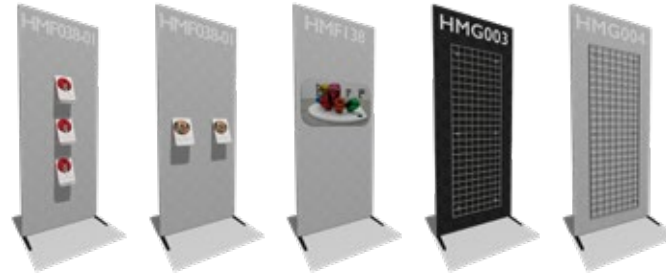

Door modules



Arch modules

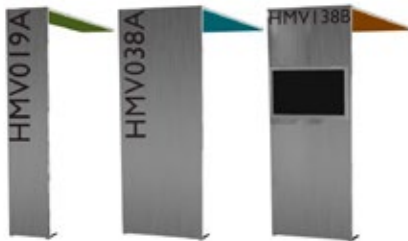

Lightbox arch modules



Lightbox velum modules



Signage modules & lightbox signs



Console modules

Storage modules

Display cases & brochure holders

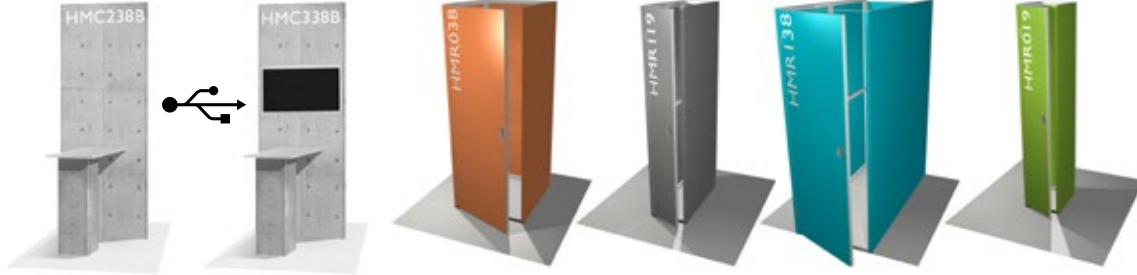

Header modules

Transparent modules

Accessories & Features

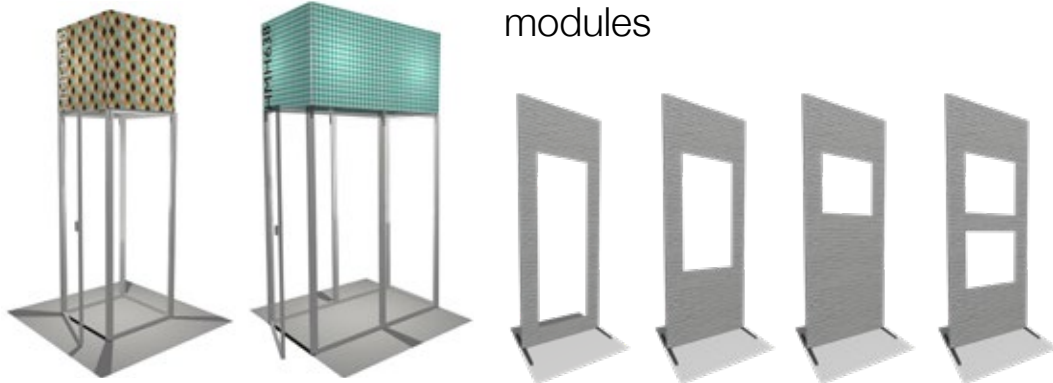

Counter modules

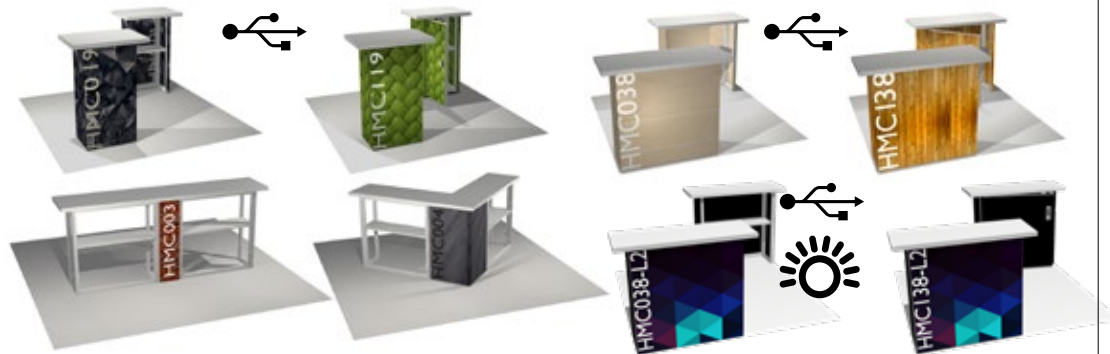

Optional USB port

Display cases & brochure holders (see p.75)

For more information, ask for the panoramic h-line brochure



h10-03

Contact us to request a quote for a purchase or rental

Suggested transport solution
1 h-line H3 crate

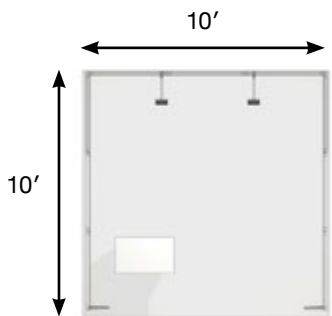

height 93"



HMC119 counter



LED light



Simply add 3 more standard 38" modules to turn it into a 10'x20' exhibit



h10-06

Contact us to request a quote for a purchase or rental

Suggested transport solution
1 h-line H3 crate

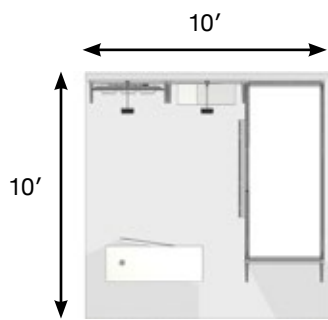

height 93"



HMC038 counter with USB hub



Add new modules and accessories to create a customized 10'x20' exhibit



h10-o8

Contact us to request a quote for a purchase or rental

Suggested transport solution

1 h-line H3 crate

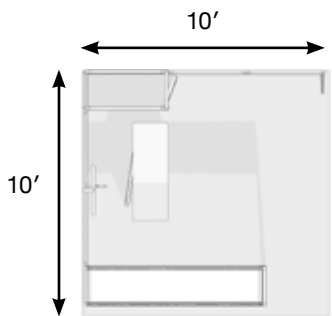

height 93"



Create a backlit arch in width of 19"



Add 2 standard modules and a TV module to turn into a 10'x20' exhibit



h10-01

Contact us to request a quote for a purchase or rental

Suggested transport solution

3 flightcases for LED panels
+ 1 48" x 96" pallet

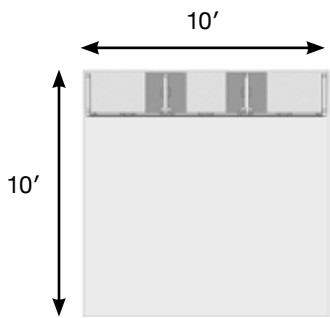

height 93"

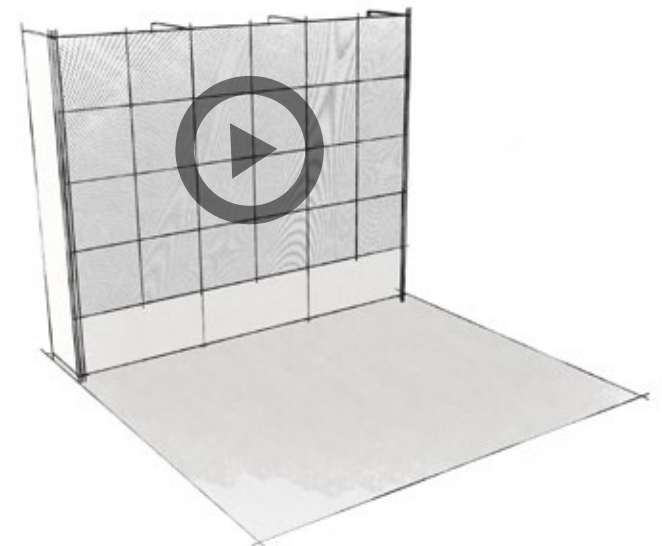
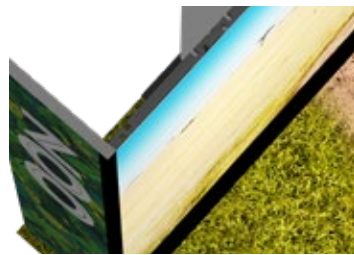

Broadcast your message on panoLED video walls



h10-02

Contact us to request a quote for a purchase or rental

Suggested transport solution

2 flightcases for LED panels
+ 1 h-line H3 crate

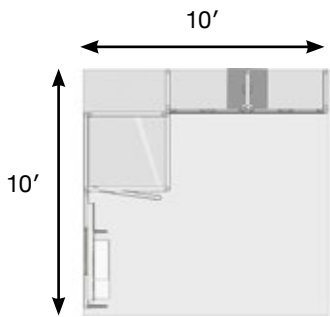

height 93"



Use compatible frames to align your video wall height to the exhibit height

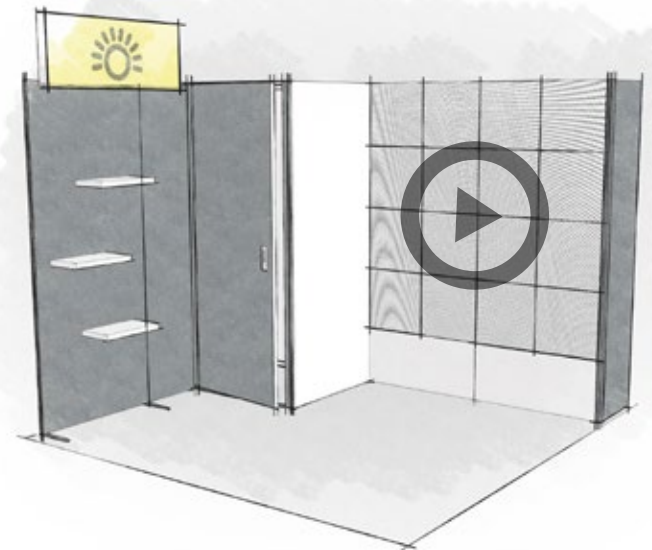



Display your items on shelves

h10-07

Contact us to request a quote for a purchase or rental

Suggested transport solution
1 h-line H3 crate

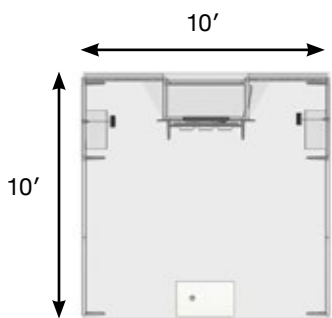

10'

10'

height 93"



3 brochure holders module + TV (HMM638)

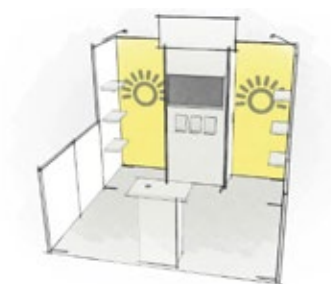

Add 2 38" lightbox modules and 2 standard 19" modules to create a 10'x20' exhibit

Combine different heights to increase impact



h20-27

Contact us to request a quote for a purchase or rental

Suggested transport solution
1 h-line H3 crate

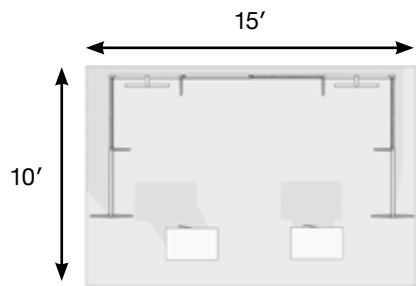

height 95"



Backlit and non-backlit modules

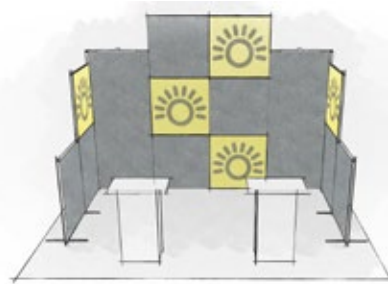

Add 2 lightbox modules and 2 standard modules to turn into a 10'x20' exhibit

Signature spotlight for powerful, homogeneous lighting



h20-12

Contact us to request a quote for a purchase or rental

Suggested transport solution

1 h-line H3 crate

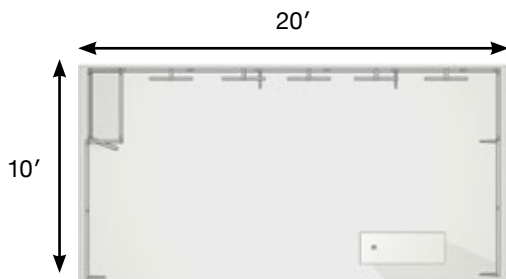

height 93"



HMC038 counter



HMR119 storage module



Remove modules and adapt to a smaller area: 10'x10'

Increase visibility with a header



h20-28

Contact us to request a quote for a purchase or rental

Suggested transport solution

1 h-line H3 crate

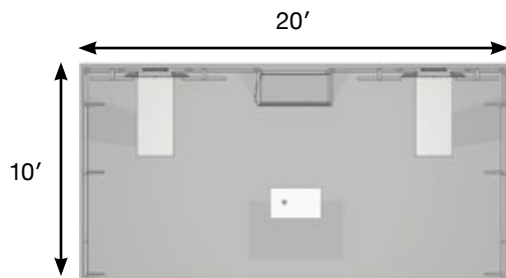

height 93"
header height: 38"



Interior shelf in each console

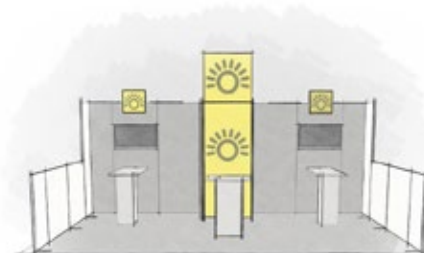

Remove modules and adapt to a smaller area: 10'x10'



Increase the impact of your communication with lightbox modules

USB hub

h20-24

Contact us to request a quote for a purchase or rental

Suggested transport solution
2 h-line H3 crates



height 93"
header height: 38"



Brochure holders and TV



2 HMC038-USB counters connected with HMC003



Add header modules to transform your exhibit into a central 20'x20' island

Vary your messages with wall.frame



h20-26

Contact us to request a quote for a purchase or rental

Suggested transport solution

1 h-line H3 crate

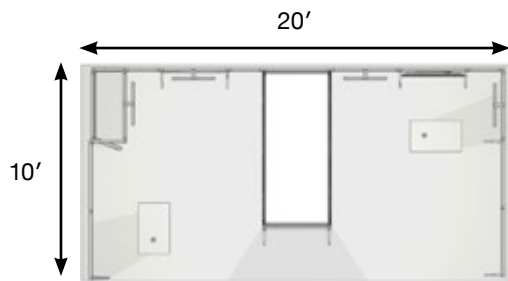

height 93"



storage module HMR119



Increase the size of your exhibit to 10'x30': add 1 storage module, 1 arch and 1 counter



Even more impact with the panoLED video wall



h20-11

Contact us to request a quote for a purchase or rental

Suggested transport solution

2 flightcases for LED panels
+ 1 h-line H3 crate

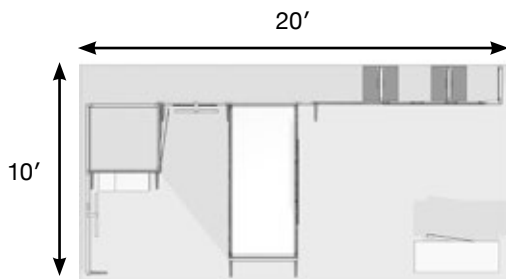

height 93"
header height: 38"



Create an optical illusion effect by combining still graphics and animated videos

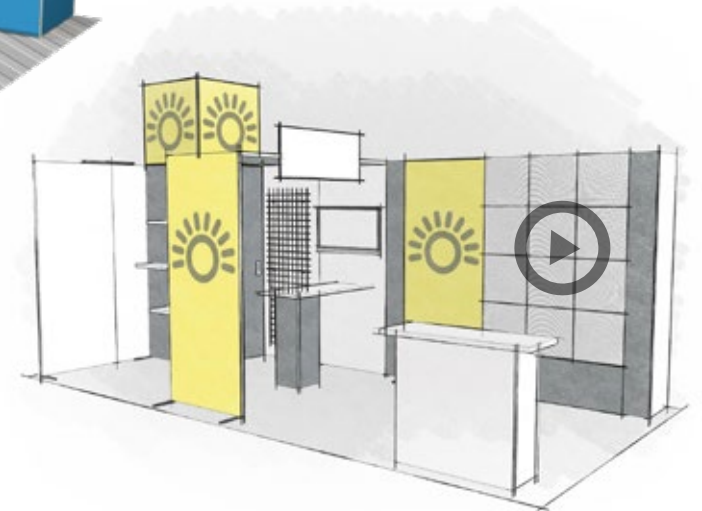



h20-29

Contact us to request a quote for a purchase or rental

Suggested transport solution
2 h-line H3 crates

Connect two counters using the connection module

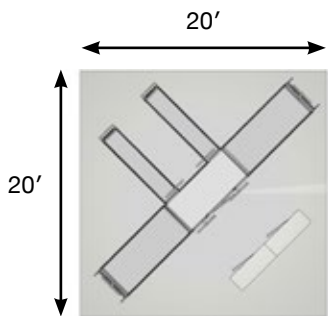

height 131"



Lightbox signs to display your logo

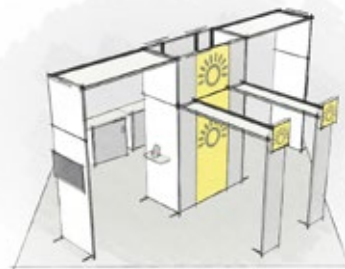

Add 2 standard 38" modules, 1 19" module and 1 9" module to change the layout of your exhibit to 10'x20'



h20-10

Contact us to request a quote for a purchase or rental

Suggested transport solution
2 h-line H3 crates

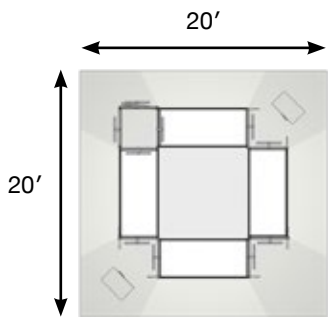

height 131"



Arch module with lightbox
velum HMV438-L

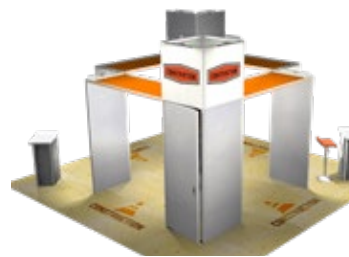

HMR038 storage
module



Create a very different design
using the same area and more functionalities

Showcase your products with the helix.200 display case



h30-02

Contact us to request a quote for a purchase or rental

Suggested transport solution
2 h-line H3 crates

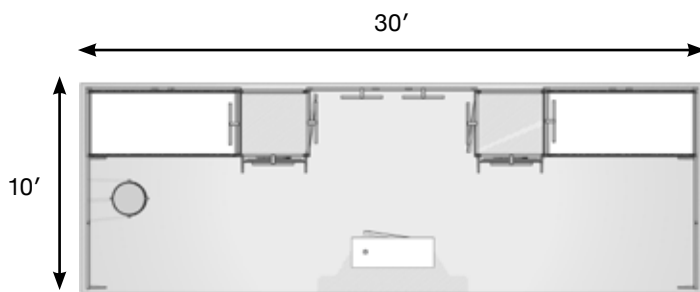
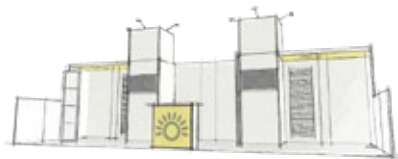

height 93"
header height: 38"



Grid module to attach various accessories



Remove modules and adapt your exhibit to a smaller area: 10'x20'

Counters, to greet visitors!

panoramic®
h-line



hmc119

S counter module with door
(19" x 38" x 12") + graphics

hmc119-usb 

Option with USB hub

Counter height
39.4"

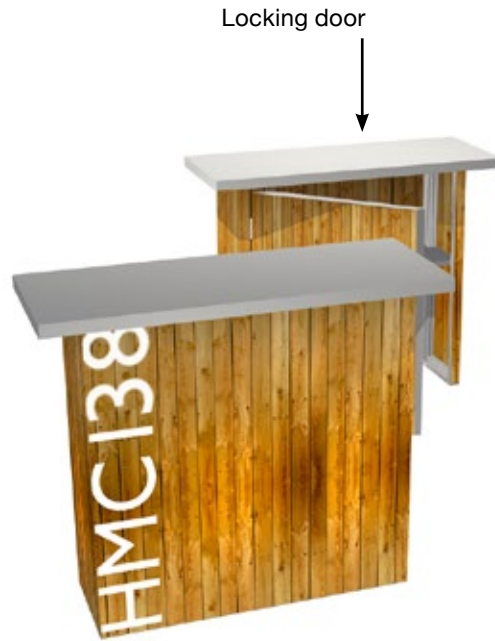

hmc138

M counter module with door
(38" x 38" x 12") + graphics

hmc138-usb 

Option with USB hub

Counter height
39.4"



hmc138-L2

M counter module with door and
lighted front + graphics

hmc138-L2-usb 

Option with USB hub

Counter height
39.4"

panoramic h-line counters are usually sold with panoramic h-line exhibits.
Please contact us for individual packaging.

Travel solutions

panoramic®
h-line



Partitionable crate



crate.h-line H3

Outer dimensions
34"L x 97"l x 60"H

Weight
370 lbs

crate.h-line H5

Outer dimensions
30.25"L x 96.5"l x 56.25"H

Weight
245 lbs

flightcase.panoLED

Outer dimensions
31.1"Lx 23.4" l x 30.1"H

Weight
121 lbs

Can hold up to 10 LED panels
(a 24.8 ft² LED video wall)

Height includes wheels and accessories compartment.



Couldn't find the perfect configuration?
Let us create it for you!



Find more configurations in our booth library at
<https://duodisplay.com/can/booth-library/>